

Concrete Boom KBR 37X-4

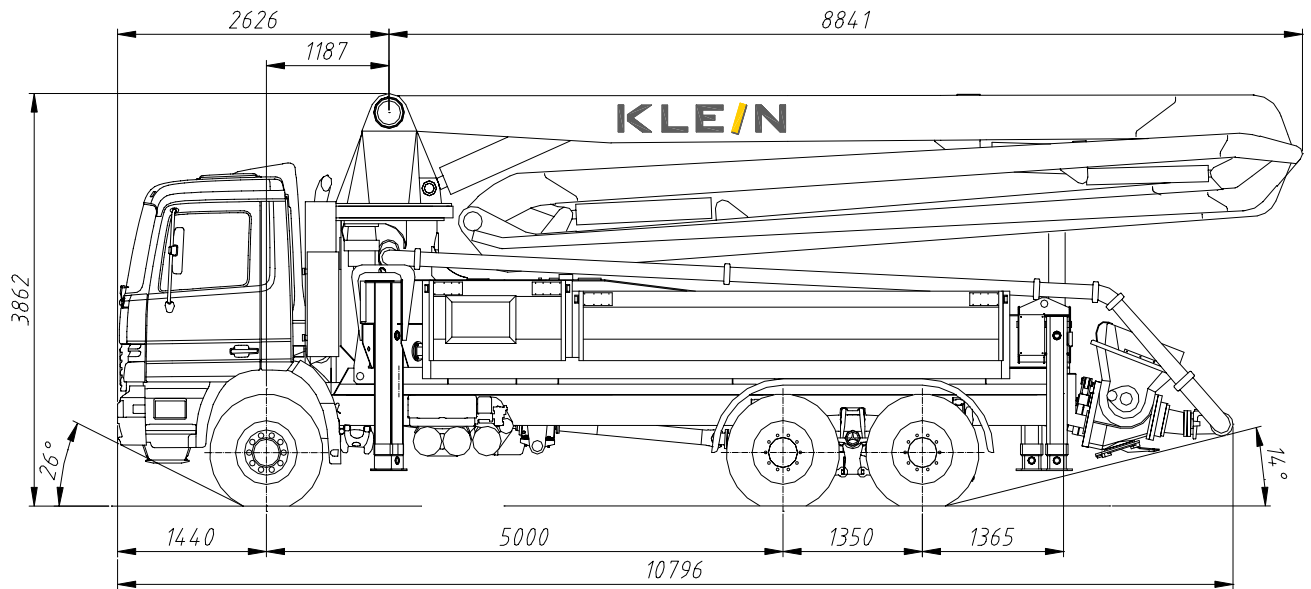

BOOM TYPE
GROSS WEIGHT, INCL. TRUCK AND STANDARD PUMP UNIT

KBR 37X-4
app. G=26.000 kg

CONSTRUCTION

The boom, consisting of boom base, swivel head, outriggers and boom sections, is made of high quality fine grained steel. Thereby a maximum of stability is reached by a minimum of weight. All boom sections are moved hydraulically. A rotary joint swivels the distributor boom by an hydraulically driven multi-stage planetary gear.

Because of this specific construction any position within the operating capacity of the boom can be reached.

OUTRIGGERS

By using hydraulically moved outriggers, which are integrated in the boom base, an optimum of stability of the machine during work is warranted.

CONCRETE PIPELINE

The concrete conveying line has a inner diameter of 125 mm. It consists of standard pipes and standard cast bends which are connected by snap couplings. Therefore in case of need the parts could be changed quickly. A final flexible tube will be mounted at the end of the boom.

CONTROLS

All functions of the distributor boom are controlled hydraulically by using a proportional control block. This control block is operated by a cable or alternatively by a radio remote control. Because of safety reasons, on all boom cylinders, the swing gear and the outriggers, boom hydraulic cylinder check valves are mounted which provide safety against overloads and pipe bursts.

The housings of the control units consist of shock resistant airtight and dustproof plastic material. By several easily accessible emergency stop buttons the distributor boom can be switched off without any time lag.

The herein stated specifications and technical data purely describes guidelines and are therefore not binding. Because of technical progress modifications are subject to change without notice.

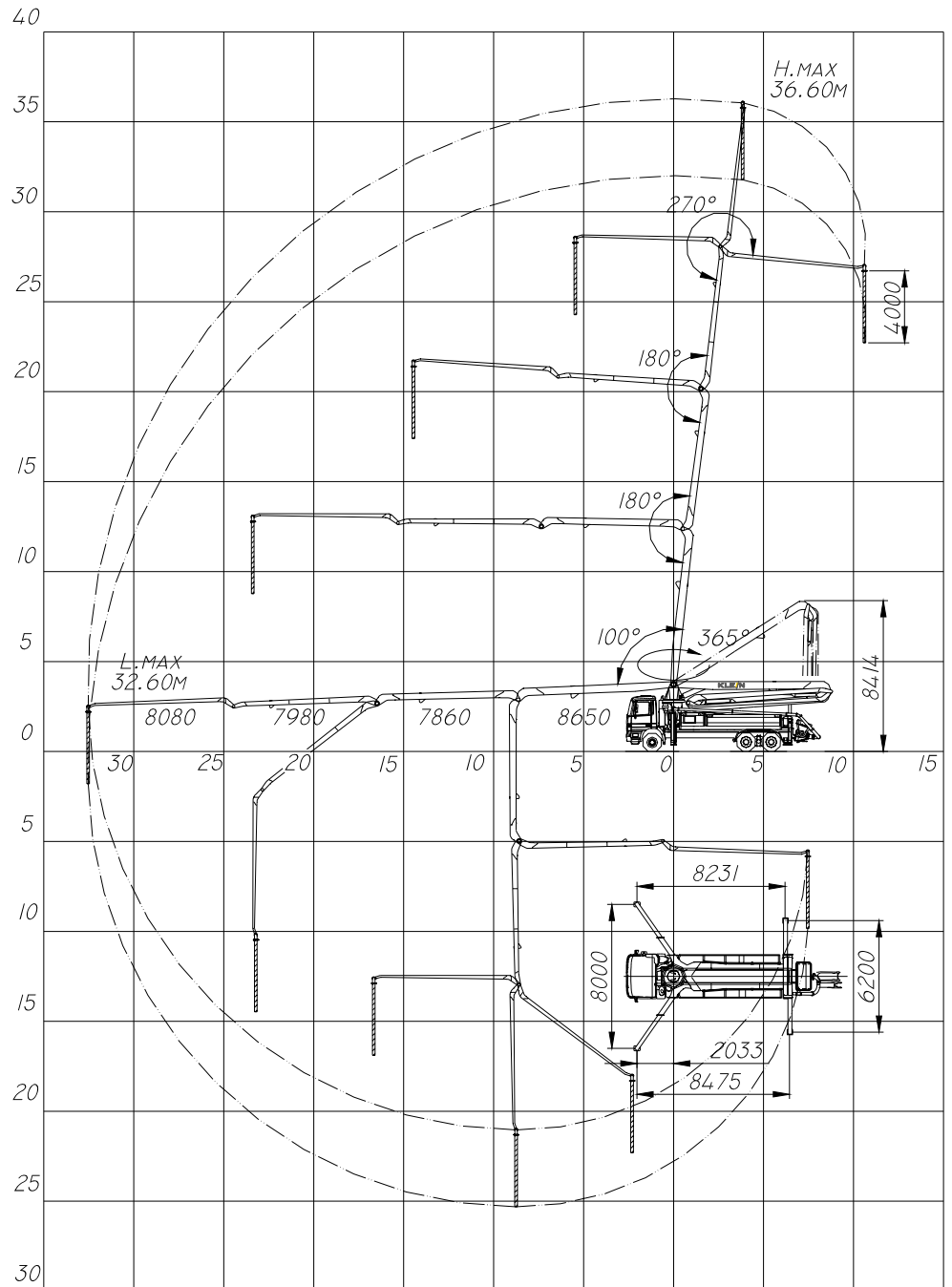

TECHNICAL DATA KBR 37X-4

Concrete line diameter	mm	125	1st element rotation	100°
Max. vertical reach	m	36.60	2nd element rotation	180°
Horizontal reach	m	32.60	3rd element rotation	180°
Min. opening height	mm	8414	4th element rotation	270°
Final flexible tube	m	4		
Slewing ranch		365°		
Max. hydr. working pressure	bar	320	Electrical system	12V / 24V

KLEIN

Klein GmbH
 Messerschmittstrasse 12
 89343 Jettingen-Scheppach – Germany
Telefon: +49-(0)-8225-95992-0
 Telefax: +49-(0)-8225-95992-55
 E-Mail: info@kleingmbh.de
 Internet: www.kleingmbh.de

Klein of America Inc.
 4293 County Rd. 46
 Maidstone, ON N0R 1K0 – Canada
 E-Mail: info@kleingmbh.com
 Internet: www.kleingmbh.com